

# 4

## ZAGEN SCIES À COUPE

HANDZAGEN VOOR HOUTBEWERKING

SPECIALE ZAGEN

MATERIAALZAGEN

BEUGELZAGEN

METAALZAGEN

DECOUPEERZAAGBLADEN

GATZAGEN

CIRKELZAAGBLADEN

*SCIES ÉGOÏNES POUR TRAVAIL DU BOIS*

*SCIES SPÉCIALES*

*SCIES ÉGOÏNES*

*SCIES À BÛCHES*

*SCIES À MÉTAUX*

*LAMES DE SCIES SAUTEUSE*

*SCIES-TRÉPANS*

*LAMES DE SCIES CIRCULAIRES*





# XPERT

XPERT drievoudig geslepen hardpoint vertanding TGT,  
1 mm bladdikte

XPERT denture triple tranchant trempée hardpoint TGT,  
épaisseur de lame 1 mm

code								€
			L mm	# inch/pouce				
<b>Universele vertanding • Denture universelle</b>								
IR 10505539	vrac	5706915055399	450	8 - 9	415 gr	4	1	20,95
IR 10505540	vrac	5706915055405	500	8 - 9	452 gr	4	1	21,90
IR 10505541	vrac	5706915055412	550	8 - 9	492 gr	4	1	23,16
<b>Fijne vertanding • Denture fine</b>								
IR 10505556	vrac	5706915055566	500	10 - 11	456 gr	4	1	21,90
<b>Grove vertanding (herslijpbaar) • Denture grosse (réaffûtable) - XP 3033</b>								
IR 10503530	vrac	5715110475802	500	3,5 - 4	466 gr	4	1	23,49
IR 10503531	vrac	5715110427191	600	3,5 - 4	577 gr	4	1	24,35



PFTE coating voor een minimale wrijving • Revêtement PFTE minimise la friction

Universele vertanding • Denture universelle

IR 10505546	vrac	5706915055467	550	8 - 9	494 gr	4	1	29,86
<b>Fijne vertanding • Denture fine</b>								
IR 10505602	vrac	5706915056020	500	10 - 11	462 gr	4	1	27,26

EVO hardpoint vertanding  
EVO denture trempée hardpoint



# EVO

code								€
			L mm	# inch/pouce				
<b>Universele vertanding • Denture universelle</b>								
IR 10507858	vrac	5706915078589	490	10	410 gr	10	1	19,16



+ 20% Meer efficient • Plus efficace  
+ 29% Snelheid • Vitesse  
+ 38% Snijkwaliteit • Qualité de coupe

**PLUS** dubbel geslepen hardpoint vertanding,  
0,85 mm bladdikte  
**PLUS** denture à double tranchant trempée hardpoint,  
épaisseur de lame 0,85 mm

code								€
		L mm # inch/pouce						
<b>Universele vertanding • Denture universelle - PL 880</b>								
IR 10503623	vrac	5706915936230	450	8 - 9	346 gr	10	1	<b>12,82</b>
IR 10503624	vrac	5706915936247	500	8 - 9	383 gr	10	1	<b>13,19</b>
<b>Fijne vertanding • Denture fine - PL 990</b>								
IR 10503630	vrac	5706915936308	500	9 - 10	374 gr	10	1	<b>13,19</b>
<b>Grove vertanding • Denture grosse - PL 770</b>								
IR 10503626	vrac	5706915936261	550	7 - 8	403 gr	10	1	<b>13,57</b>

**PLUS**

**ENTRY** hardpoint vertanding • **ENTRY** denture trempée hardpoint

code								€
		L mm # inch/pouce						
<b>Universele vertanding • Denture universelle</b>								
IR 10505307	vrac	5715110429232	500	7 - 8	350 gr	10	1	<b>11,56</b>

**ENTRY**



**Kapzaag dubbel geslepen hardpoint vertanding**  
**Scie à dos, fine denture trempée hardpoint**

code								€
			L mm	# inch/pouce				

**Fijne vertanding • Denture fine - XP 3055**

IR 10503534	vrac	5706915035346	300	12 - 13	378 gr	4	1	<b>19,47</b>
IR 10503535	vrac	5706915035353	350	12 - 13	550 gr	4	1	<b>20,05</b>

**Fineerzaag met neustanden, fijne hardpoint vertanding TGT**  
**Scie à panneau, fine denture trempée hardpoint TGT**

code								€
			L mm	# inch/pouce				

**Fijne vertanding • Denture fine - XP 3049**

IR 10503533	vrac	5706915035339	325	12 - 13	304 gr	4	1	<b>17,43</b>
-------------	------	---------------	-----	---------	--------	---	---	--------------

**Schrobzaag drievoudig geslepen hardpoint vertanding TGT**  
**Scie à guichet denture triple tranchant trempée hardpoint TGT**

code								€
			L mm	# inch/pouce				

**Fijne vertanding • Denture fine - XP 3047**

IR 10503532	vrac	5706915035322	300	7 - 8	222 gr	4	1	<b>14,34</b>
-------------	------	---------------	-----	-------	--------	---	---	--------------

**Steekzaag ideaal voor gipsplaten, zeer stijf blad**  
**Poignard pour plaque de plâtre, lame très rigide**

code								€
			L mm	# inch/pouce				

**SOFT GRIP greep • Manche SOFT GRIP**

ED 670		3476060006707	150	7 - 8	150 gr	15	1	<b>14,57</b>
--------	--	---------------	-----	-------	--------	----	---	--------------

**Houten greep • Manche bois**

CP 368415	vrac	4022307158167	150	7 - 8	82 gr	12	1	<b>5,10</b>
-----------	------	---------------	-----	-------	-------	----	---	-------------

**Verstekzaag • Scie à onglet**

code							€
			mm				

CP 900000	vrac	4022307159812	550	4200 gr	1	1	<b>49,20</b>
-----------	------	---------------	-----	---------	---	---	--------------

**Verstebak in essenhout • Boîte à onglet en bois de hêtre**

code							€
			mm				

CP 902530	vrac	4022307139296	300 x 53 x 40	386 gr	1	1	<b>4,54</b>
CP 902535	vrac	4022307147239	350 x 100 x 40	606 gr	1	1	<b>8,14</b>



2,15 mm	13 TPI	0,7 mm (1,15 mm)



### Handzaag MAGNUM 300 • Scie égoïne MAGNUM 300

code							€
			L mm				
<b>TJ MG300FB</b>	vrac	4975364019028	300	555 gr	4	1	<b>38,92</b>
<b>Vervangzaagblad FLUORINE voor "MAGNUM 300" • lame de rechange FLUORINE pour "MAGNUM 300"</b>							
<b>TJ MGB300FB</b>	vrac	4975364019103	300	149 gr	12	1	<b>17,21</b>

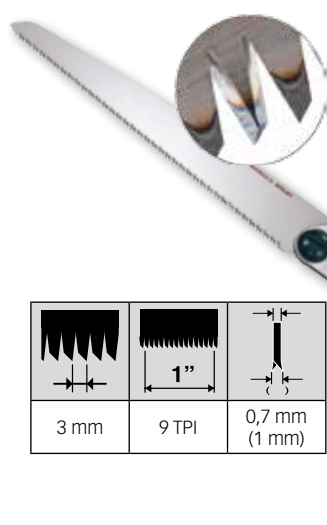

### Inklapbare zaag "G-SAW 240" • Scie pliante "G-SAW 240"

code							€
			L mm				
<b>TJ GKG240</b>	vrac	4975364015891	240	333 gr	6	1	<b>18,97</b>
<b>Vervangzaagblad voor "G-SAW 240" • lame de rechange pour "G-SAW 240"</b>							
<b>TJ GKBG240</b>	vrac	4975364015907	240	45 gr	12	1	<b>5,94</b>

3 mm	9 TPI	0,7 mm (1 mm)

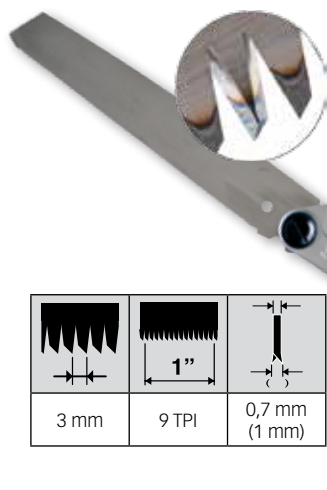

### Inklapbare zaag "G-SAW 210" • Scie pliante "G-SAW 210"

code							€
			L mm				
<b>TJ GKG210P</b>	vrac	4975364018946	210	310 gr	6	1	<b>18,71</b>
<b>Vervangzaagblad voor "G-SAW 210" • lame de rechange pour "G-SAW 210"</b>							
<b>TJ GKBG210P</b>	vrac	4975364018328	210	45 gr	12	1	<b>10,64</b>

3 mm	9 TPI	0,7 mm (1 mm)





**XPERT handzaag voor gipsplaten, drievoudig geslepen tanden TGT**  
**XPERT scie égoïne pour plaques de plâtre, denture triple tranchant TGT**

code								€
			L mm	# inch/pouce				
<b>Grove vertanding • Denture grosse</b>								
<b>IR 10505547</b>	vrac	5706915055474	550	8 - 9	494 gr	4	1	<b>31,21</b>

- Diepe expansiegaten voor een snellere afvoer
- PFTE coating voor een minimale wrijving

- Encoches d'évacuation
- Revêtement PFTE minimise la friction



RS 904

**Gasbetonzaag met geharde punten, zeer grove vertanding**  
**Scie à béton cellulaire, grosse denture trempée**

code							€
			L mm				
<b>RS 904</b>	vrac	5420000010406	650	802 gr	6	1	<b>19,18</b>



RS 903017

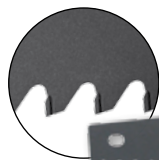

RS 903034

**Gasbetonzaag met opgelaste hardmetalen tanden**  
**Scie à béton cellulaire, denture à plaquettes au carbure de tungstène**

code							€	
			L mm					
<b>17 tanden • 17 dents</b>								
<b>RS 903017</b>	vrac	5420000010413	650	806 gr	12	1	<b>25,81</b>	
<b>33 tanden • 33 dents</b>								
<b>RS 903034</b>	vrac	5420000010420	650	806 gr	6	1	<b>32,83</b>	
<b>21 tanden • 21 dents</b>								
<b>RS 903022</b>	vrac	5420000010604	450	668 gr	12	1	<b>29,82</b>	



RS 903022



PRO



### Beugelzaag met zaagblad voor groen hout Scie à bûche avec lame pour bois vert

code							€
			L mm				
<b>PRO • PRO</b>							
IR XP1624-533	vrac	5706915000269	533	729 gr	5	1	<b>10,42</b>
IR XP1124-610	vrac	5706915000207	610	870 gr	5	1	<b>12,15</b>
IR XP1124-762	vrac	5706915000221	762	1004 gr	5	1	<b>13,13</b>

### Beugelzaagbladen • Lames de scie à bûche

code							€
			L mm				
<b>PRO • PRO</b>							
<b>Amerikaanse vertanding - groen hout • Denture Américaine - bois vert</b>							
IR XP3024-533		5715110480271	533	54 gr	10	1	<b>3,81</b>
IR XP3024-610		5715110480332	610	60 gr	10	1	<b>3,99</b>
IR XP3024-762		5715110480301	762	74 gr	10	1	<b>4,40</b>
<b>Gelijke vertanding - droog hout • Denture isocèle - bois sec</b>							
IR XP3011-300		5715110480066	300	32 gr	10	1	<b>3,68</b>
IR XP3020-533		5715110480189	533	54 gr	10	1	<b>3,81</b>
IR XP3020-762		5715110480240	762	74 gr	10	1	<b>4,40</b>



### Combi beugelzaag met 2 zaagbladen (metaal / PVC + hout) Scie à bûche avec 2 lames (métal / PVC + bois)

code							€
			L mm				
IR XP1211-300	vrac	5706915000122	300	602 gr	10	1	<b>10,20</b>

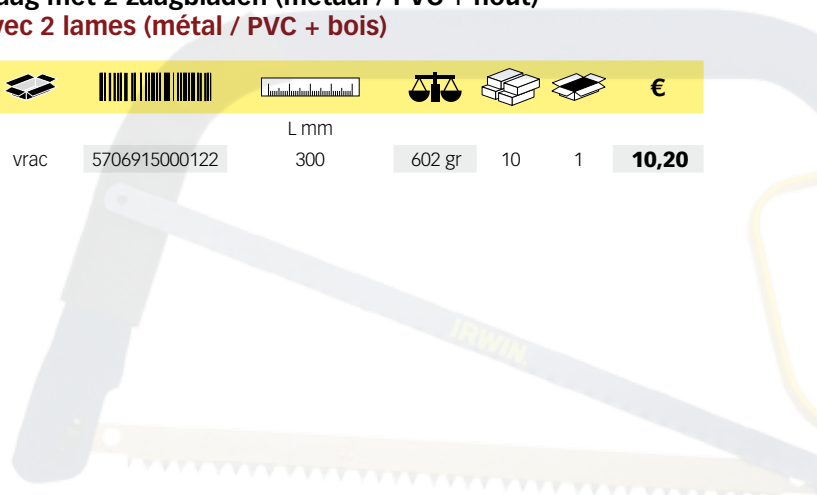



**Metaalzaagbeugel met houten handgreep**  
**Scie à métaux avec poignée bois**

code							€
RS 905000	vrac	5420000040250	L mm 300	646 gr	10	1	<b>8,37</b>

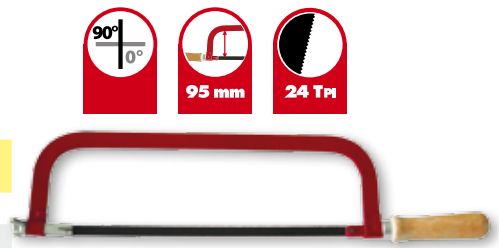

**Metaalzaagbeugel met bi-composant kunststoffen handgreep**  
**Scie à métaux avec poignée bi-composant en plastique**

code							€
RS 905010	vrac	5420000040267	L mm 300	424 gr	10	1	<b>9,23</b>

**solid Xtreme**

**Metaalzaagbeugel met bi-composant kunststoffen handgreep "Xtreme"**  
**Scie à métaux avec poignée bi-composant en plastique "Xtreme"**

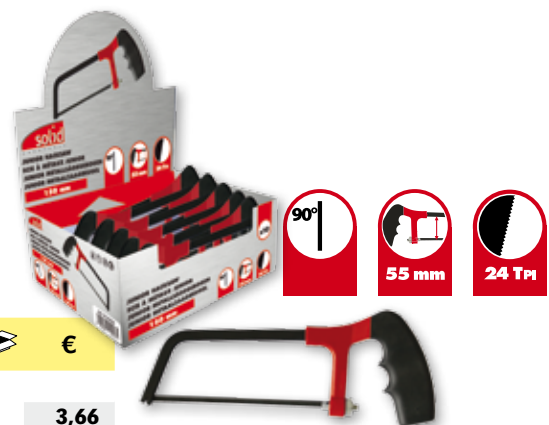
code							€
RS 905050	vrac	5420000040281	L mm 300	588 gr	10	1	<b>14,90</b>

**Junior metaalzaagbeugel • Scie à métaux junior**

code							€
RS 905020	vrac	5420000040274	L mm 150	150 gr	10	1	<b>3,66</b>



### Metaalzaagbeugel Scie à métaux



code							€
IR 10506437		5706915064377	L mm 300	626 gr	10	1	<b>18,20</b>

Bladpositionering voor vlakzagen • Permettant la coupe à ras



### Metaalzaagbeugel Scie à métaux



code							€
IR 10504407		5706915044072	L mm 300	972 gr	10	1	<b>23,44</b>

Bladpositionering voor vlakzagen • Permettant la coupe à ras

### Junior metaalzaagbeugel • Scie à métaux junior



code							€
IR 10504409		5706915044096	L mm 150	240 gr	5	1	<b>10,23</b>



### Metaalzaagbladen • Lames de scie à métaux



code					TPI DPP			prijs per prix par	€
L mm									
<b>Koolstofstaal • Acier au carbone</b>									
IR 10504530		5706915045307	150	hout/bois	14	44 gr	100	10	<b>5,07</b>
IR 10504531		5706915045314	150	metaal-pvc / métal-pvc	32	50 gr	100	10	<b>5,07</b>
<b>BI-METAL • BI-METAL</b>									
IR 10504524		5706915045246	300	metaal-pvc / métal-pvc	24	49 gr	20	2	<b>3,31</b>
IR 10504520	box	5706915045208	300	metaal-pvc / métal-pvc	18	1845 gr	400	100	<b>154,40</b>
IR 10504521	box	5706915045215	300	metaal-pvc / métal-pvc	24	1924 gr	400	100	<b>154,40</b>
IR 10504522	box	5706915045222	300	metaal-pvc / métal-pvc	32	1940 gr	400	100	<b>154,40</b>



### Metaalzaagbeugel met hoge spanning Scie à métaux avec une tension forte

code							€
LX 20918-4012		5706915075427	L mm 300	813 gr	5	1	<b>41,07</b>

### Metaalzaagbladen bi-metaal extra lange levensduur Lames de scie à métaux bi-métal durée de vie prolongée

code				TPI DPP			prijs per prix par	€
LX 20144		0082472201444	L mm 300	18	194 gr	100	10	<b>26,22</b>
LX 20145		0082472201451	L mm 300	24	197 gr	100	10	<b>26,22</b>



### Compacte metaalzaagbeugel ideaal voor moeilijk te bereiken plaatsen Scie à métaux, conçue pour les endroits difficilement accessible



code							€
LX 20975		0082472209754	L mm 250	87 gr	5	1	<b>13,08</b>



### Handzaag speciaal voor PVC / ABS kunststofbuizen Scie spécial pour tubes PVC / ABS

code				TPI DPP				€
LX 20980		0082472209808	L mm 450	10	518 gr	5	1	<b>32,96</b>



TPI tanden per inch  
DPP dents par pouce

HOUT EN DERIVATEN  
BOIS ET DERIVES

SAMENGESTELDE MATERIELEN  
COMPOSITES

KUNSTSTOFFEN  
MATIERES PLASTIQUES

HOUT MET SPIJKERS  
BOIS AVEC CLOUS

METALEN  
METAUX

**"TUFF TOOTH" bi-metaal reciprozsaagbladen**  
Voor een betere zaagprestatie en langere levensduur  
**Lames de scie recipro bi-métal "TUFF TOOTH"**  
Pour des résultats optimaux, durée de vie prolongée



code					TPI DPP		prijs per prix par	€
			mm					

Snel zagen, grof zaagwerk, hout met spijkers • Coupe rapide, grossière, bois avec clous

LX 20572-656R		0082472205725	152 x 20 x 1,3		6	99 gr	5	<b>25,38</b>
LX 20582-956R		0082472205824	229 x 20 x 1,3		6	183 gr	5	<b>33,46</b>
LX 20585-156R		0082472205855	305 x 20 x 1,3		6	255 gr	5	<b>40,41</b>

Hout met spijkers, samengestelde materialen en kunststoffen, buizen, koolstofstaal, roestvrij staal:  
3,2 - 6 mm, non-ferrometaal: 3,2 - 13 mm

Bois avec clous, matériaux composites et plastique, tubes, acier au carbone, acier inoxydable:  
3,2 - 6 mm, métaux non ferreux: 3,2 - 13 mm

LX 20562-610R		0082472205626	152 x 20 x 0,9		10	94 gr	5	<b>20,63</b>
LX 20580-810R		0082472205800	203 x 20 x 1,3		10	174 gr	5	<b>26,90</b>
LX 20590-B810R	box	0082472205909	203 x 20 x 1,3		10	898 gr	25	<b>125,54</b>
LX 20583-110R		0082472205831	305 x 20 x 1,3		10/14	257 gr	5	<b>40,41</b>

Constructiestaal, buizen, roestvrij staal: 2,5 - 6 mm, non-ferrometaal: 2,5 - 8 mm

Acier de construction, tubes, acier inoxydable: 2,5 - 6 mm, métaux non ferreux: 2,5 - 8 mm

LX 20564-614R		0082472205640	152 x 20 x 0,9		14	95 gr	5	<b>20,63</b>
LX 20494B-614R	box	0082472204940	152 x 20 x 0,9		14	400 gr	25	<b>95,89</b>
LX 20566-618R		0082472205664	152 x 20 x 0,9		18	95 gr	5	<b>20,63</b>
LX 20529-B618R	box	0082472205299	152 x 20 x 0,9		18	471 gr	25	<b>95,52</b>
LX 20578-818R		0082472205787	203 x 20 x 0,9		18	132 gr	5	<b>26,90</b>
LX 20487-B818R	box	0082472204872	203 x 20 x 0,9		18	661 gr	25	<b>125,54</b>

Alle metalen met een dikte <3,2 mm (buizen, profielen, sierlijsten, ...)

Tous les métaux avec épaisseur <3,2 mm (tubes, profilés, moulures, ...)

LX 20568-624R		0082472205688	152 x 20 x 0,9		24	96 gr	5	<b>20,63</b>
---------------	--	---------------	----------------	--	----	-------	---	--------------



**"LAZER" - zagen in extreem metaal**  
couper des métaux extrême - **"LAZER"**



code					TPI DPP		prijs per prix par	€
			mm					

LX 20170-6110R		0082472201703	152 x 25 x 1,1		10	152 gr	5	<b>29,79</b>
LX 20172-6114R		0082472201727	152 x 25 x 1,1		14	160 gr	5	<b>29,79</b>
LX 20178-9114R		0082472201789	229 x 25 x 1,1		14	244 gr	5	<b>37,33</b>
LX 20184-12114R		0082472201840	305 x 25 x 1,1		14	370 gr	5	<b>42,47</b>
LX 20185B-12114R	box	0082472201857	305 x 25 x 1,1		14	1700 gr	25	<b>207,30</b>

**"DEMOLITION" sloopwerkzaamheden, hout en metaal**  
Travaux de démolition, bois et métal **"DEMOLITION"**



code					TPI DPP		prijs per prix par	€
			mm					

LX 20597-960R		0082472205978	229 x 28 x 1,6		10	136 gr	2	<b>21,79</b>
LX 20598-966R		0082472205985	229 x 28 x 1,6		6	134 gr	2	<b>21,79</b>

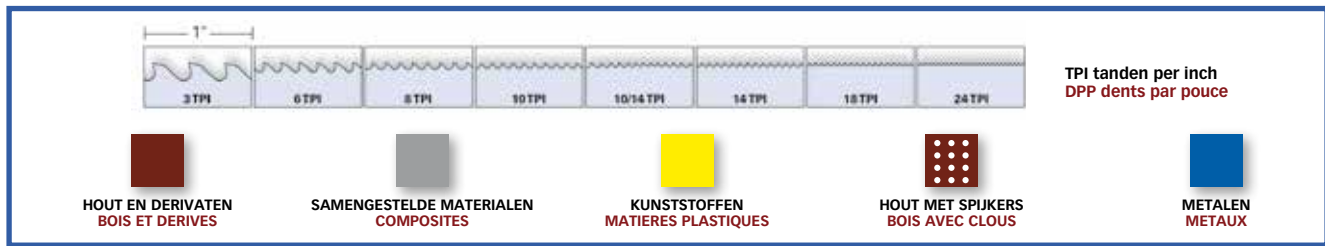

### "T-SCHACHT" decoupeerzaagbladen Lames de scie sauteuse "ATTACHE-T"

code						TPI DPP		prijs per prix par	€
				mm					
<b>BI-METAAL • BI-METAL</b>									
LX 20305		0082472203059		100 x 10 x 1,3	10 > 50	6	21 gr	2	<b>6,96</b>
LX 20315		0082472203158		100 x 8 x 1,3	10 > 50	6	17 gr	2	<b>11,79</b>
LX 20312		0082472203127		100 x 6 x 1,3	10 > 38	6	15 gr	2	<b>11,16</b>
LX 20306		0082472203066		100 x 10 x 1,3	3,2 > 25	10	20 gr	2	<b>6,96</b>
LX 20813		0082472208139		100 x 10 x 1,3	3,2 > 25	10	210 gr	25	<b>82,69</b>
LX 20313		0082472203134		100 x 8 x 1,3	5 > 38	10	17 gr	2	<b>11,48</b>
LX 20314		0082472203141		100 x 8 x 1,3	5 > 38	10	17 gr	2	<b>11,48</b>
LX 20311		0082472203110		82 x 5 x 1,3	1,5 > 13	20	10 gr	2	<b>10,90</b>
LX 20301		0082472203011		92 x 10 x 0,9	2,5 > 6	14	16 gr	2	<b>6,84</b>
LX 20302		0082472203028		92 x 10 x 0,9	1,5 > 6	18	16 gr	2	<b>6,84</b>
LX 20308		0082472203080		135 x 10 x 1,3	1,5 > 5	18	28 gr	2	<b>11,93</b>
LX 20303		0082472203035		92 x 10 x 0,9	< 3,2	24	16 gr	2	<b>6,84</b>
LX 20309		0082472203097		150 x 10 x 1,3	< 100	6	32 gr	2	<b>13,39</b>
<b>KOOLSTOFSTAAL • ACIER AU CARBONE</b>									
LX 20298		0082472202984		100 x 10 x 1,3	10 > 50	6	47 gr	5	<b>14,22</b>
LX 20296		0082472202960		100 x 8 x 1,5	5 > 38	10	38 gr	5	<b>16,73</b>



### Decoupeerzaagbladen (carbide) voor fiber en gipsplaat Lames de scie sauteuse (carbone) pour fibre et plâtre

code				TPI DPP				€	
				mm					
<b>T - SCHACHT • ATTACHE-T</b>									
IR 10505816		5706915058161	132	6	17 gr	1	1	<b>21,01</b>	



**Decoupeerzaagbladen voor hout - verpakt per 5 stuks**  
**Lames de scie sauteuse pour bois - emballées par 5 pièces**

code				TPI DPP				€
			mm					
<b>T - SCHACHT • ATTACHE-T</b>								
IR 10504219		5706915042191	100	10	38 gr	10	5	<b>7,10</b>
IR 10504221		5706915042214	100	8	40 gr	10	5	<b>5,69</b>
IR 10504222		5706915042221	100	6	37 gr	10	5	<b>7,10</b>
IR 10504226		5706915042269	83	20	25 gr	10	5	<b>8,24</b>
IR 10504227		5706915042276	83	12	23 gr	10	5	<b>8,24</b>
IR 10504228		5706915042283	117	8-13	46 gr	10	5	<b>11,39</b>
<b>U - SCHACHT • ATTACHE-U</b>								
IR 10504292		5706915042924	92	6	29 gr	10	5	<b>8,24</b>
IR 10504290		5706915042900	92	8	38 gr	10	5	<b>5,44</b>



**Decoupeerzaagbladen voor metaal - verpakt per 5 stuks**  
**Lames de scie sauteuse pour métal - emballées par 5 pièces**

code				TPI DPP				€
			mm					
<b>T - SCHACHT • ATTACHE-T</b>								
IR 10504220		5706915042207	92	17-23	32 gr	10	5	<b>8,98</b>
IR 10504234		5706915042344	92	36	33 gr	10	5	<b>8,98</b>
<b>U - SCHACHT • ATTACHE-U</b>								
IR 10504289		5706915042894	70	24	23 gr	10	5	<b>8,51</b>
IR 10504294		5706915042948	70	36	24 gr	10	5	<b>8,51</b>
IR 10504297		5706915042979	92	10-20	34 gr	10	5	<b>13,93</b>



**Decoupeerzaagbladen voor hout en metaal - verpakt per 5 stuks**  
**Lames de scie sauteuse pour bois et métal - emballées par 5 pièces**

code				TPI DPP				€
			mm					
<b>T - SCHACHT • ATTACHE-T</b>								
IR 10504232		5706915042320	132	5-10	53 gr	10	5	<b>18,46</b>
<b>U - SCHACHT • ATTACHE-U</b>								
IR 10504296		5706915042962	125	5-10	51 gr	10	5	<b>18,16</b>

**Decoupeerzaagbladenset - T-schacht**  
**Set de lames de scie sauteuse - attache-T**

code							€
<b>Inhoud / Contenu : 2 x 10504221, 2 x 10504218, 2 x 10504219, 1 x 10504222, 2 x 10504220, 1 x 10504225</b>							
IR 10505817		5706915058178	10-delig / 10 pièces	97 gr	5	1	<b>17,27</b>





### "VARI-TOOTH" bi-metaal / bi-métal

Voor optimale resultaten in hout, metaal en inox  
Pour des résultats optimaux dans le bois, le métal et l'inox



**NEW BI-METAL SPEED SLOT**



**2 X SNELLER PLUS RAPIDE**

















































**2 X LANGERE LEVENSDUUR PLUS DE LONGÉVITÉ**



DISPLAY LX AP100

Details op aanvraag  
Détails sur demande

code			Ø					€
LX 30009L-14		0082472300093	14	1L, 4L, 5L	34 gr	10	1	16,07
LX 30010L-16		0082472300109	16	1L, 4L, 5L	33 gr	10	1	12,86
LX 30011L-17		0082472300116	17	1L, 4L, 5L	39 gr	10	1	12,86
LX 30012L-19		0082472300123	19	1L, 4L, 5L	38 gr	10	1	12,86
LX 30098-20MM		0082472300987	20	1L, 4L, 5L	41 gr	10	1	12,86
LX 30013L-21		0082472300130	21	1L, 4L, 5L	43 gr	10	1	12,86
LX 30014L-22		0082472300147	22	1L, 4L, 5L	48 gr	10	1	12,86
LX 30015L-24		0082472300154	24	1L, 4L, 5L	52 gr	10	1	12,86
LX 30016L-25		0082472300161	25	1L, 4L, 5L	57 gr	10	1	13,67
LX 30017L-27		0082472300178	27	1L, 4L, 5L	61 gr	10	1	13,67
LX 30018L-29		0082472300185	29	1L, 4L, 5L	67 gr	10	1	13,67
LX 30019L-30		0082472300192	30	1L, 4L, 5L	72 gr	10	1	13,67
LX 30020L-32		0082472300208	32	2L, 3L, 6L	81 gr	10	1	13,67
LX 30021L-33		0082472300215	33	2L, 3L, 6L	87 gr	10	1	13,67
LX 30022L-35		0082472300222	35	2L, 3L, 6L	96 gr	10	1	14,42
LX 30023L-37		0082472300239	37	2L, 3L, 6L	103 gr	10	1	14,42
LX 30024L-38		0082472300246	38	2L, 3L, 6L, 7L	70 gr	10	1	14,42
LX 30025L-40		0082472300253	40	2L, 3L, 6L, 7L	74 gr	10	1	14,42
LX 30026L-41		0082472300260	41	2L, 3L, 6L, 7L	79 gr	10	1	14,42
LX 30027L-43		0082472300277	43	2L, 3L, 6L, 7L	83 gr	10	1	14,42
LX 30028L-44		0082472300284	44	2L, 3L, 6L, 7L	88 gr	10	1	18,09
LX 30029L-46		0082472300291	46	2L, 3L, 6L, 7L	97 gr	5	1	18,09
LX 30030L-48		0082472300307	48	2L, 3L, 6L, 7L	101 gr	5	1	18,09
LX 30032L-51		0082472300321	51	2L, 3L, 6L, 7L	124 gr	5	1	18,09
LX 30033L-52		0082472300338	52	2L, 3L, 6L, 7L	127 gr	5	1	22,27
LX 30034L-54		0082472300345	54	2L, 3L, 6L, 7L	133 gr	5	1	22,27
LX 30036L-57		0082472300369	57	2L, 3L, 6L, 7L	136 gr	5	1	22,27
LX 30038L-60		0082472300383	60	2L, 3L, 6L, 7L	157 gr	5	1	22,27
LX 30040L-64		0082472300406	64	2L, 3L, 6L, 7L	180 gr	5	1	24,02
LX 30041L-65		0082472300413	65	2L, 3L, 6L, 7L	187 gr	5	1	24,02
LX 30042L-67		0082472300420	67	2L, 3L, 6L, 7L	189 gr	5	1	24,02
LX 30043L-68		0082472300437	68	2L, 3L, 6L, 7L	195 gr	5	1	24,02
LX 30044L-70		0082472300444	70	2L, 3L, 6L, 7L	203 gr	5	1	24,02
LX 30046L-73		0082472300468	73	2L, 3L, 6L, 7L	219 gr	5	1	24,02
LX 30048L-76		0082472300482	76	2L, 3L, 6L, 7L	234 gr	5	1	25,06
LX 30050L-79		0082472300505	79	2L, 3L, 6L, 7L	248 gr	5	1	25,06
LX 30052L-83		0082472300529	83	2L, 3L, 6L, 7L	259 gr	5	1	25,06
LX 30054L-86		0082472300543	86	2L, 3L, 6L, 7L	277 gr	5	1	25,06
LX 30056L-89		0082472300567	89	2L, 3L, 6L, 7L	312 gr	5	1	25,06
LX 30058L-92		0082472300581	92	2L, 3L, 6L, 7L	355 gr	1	1	28,90
LX 30060L-95		0082472300604	95	2L, 3L, 6L, 7L	378 gr	1	1	34,18
LX 30062L-98		0082472300628	98	2L, 3L, 6L, 7L	402 gr	1	1	35,88
LX 30064L-102		0082472300642	102	2L, 3L, 6L, 7L	421 gr	1	1	37,60
LX 30066L-105		0082472300666	105	2L, 3L, 6L, 7L	443 gr	1	1	40,80
LX 30068L-108		0082472300680	108	2L, 3L, 6L, 7L	457 gr	1	1	53,45
LX 30070L-111		0082472300703	111	2L, 3L, 6L, 7L	424 gr	1	1	63,61
LX 30072L-114		0082472300727	114	2L, 3L, 6L, 7L	509 gr	1	1	73,75
LX 30076L-121		0082472300765	121	2L, 3L, 6L, 7L	579 gr	1	1	82,02
LX 30080L-127		0082472300802	127	2L, 3L, 6L, 7L	628 gr	1	1	91,07
LX 30088L-140		0082472300888	140	2L, 3L, 6L, 7L	745 gr	1	1	108,89
LX 30096L-152		0082472300963	152	2L, 3L, 6L, 7L	862 gr	1	1	127,24



LX 1768794

**Bi-Metaal gatzagensets in kunststof koffer  
Sets scies-trépan bi-métal en coffret plastique**

code							€
LX 1768436	koffer/coffre	5706915078022	loodgieter / plombier	1611 gr	1	1	<b>145,79</b>
LX 1768794	koffer/coffre	2706915078145	loodgieter / plombier	2115 gr	1	1	<b>146,67</b>
LX 1768696	koffer/coffre	5706915078114	electricier / électricien	2280 gr	1	1	<b>155,44</b>
LX 1768662	koffer/coffre	5706915078060	electricier / électricien	1506 gr	1	1	<b>135,32</b>
LX 1768556	koffer/coffre	5706915078046	electricier / électricien	2646 gr	1	1	<b>252,00</b>
LX 1768559	koffer/coffre	5706915078053	electricier / électricien	4554 gr	1	1	<b>452,00</b>

Ø 16	Ø 19	Ø 20	Ø 22	Ø 25	Ø 29	Ø 32	Ø 35	Ø 38	Ø 44	Ø 51	Ø 57	Ø 64	Ø 68	Ø 76	Ø 83	Ø 92	Ø 95	Ø 105	Ø 121	Houders Mandrins	Centreerboren Forets pilote	Adapter Adaptateur	
<b>LX 1768436 - 9-delig/pcs</b>																							
																					2L / 5L	-	1 x 30857
<b>LX 1768794 - 10-delig/pcs</b>																							
																					2L / 5L	1 x 4321	1 x 30857
<b>LX 1768696 - 10-delig/pcs</b>																							
																					2L / 5L	1 x 4321	1 x 30857
<b>LX 1768662 - 8-delig/pcs</b>																							
																					1L / 2L	-	-
<b>LX 1768556 - 17-delig/pcs</b>																							
																					1L / 2L	2 x 4321 1 x 56PD	-
<b>LX 1768559 - 21-delig/pcs</b>																							
																					1L / 2L	2 x 4321 1 x 56PD	-

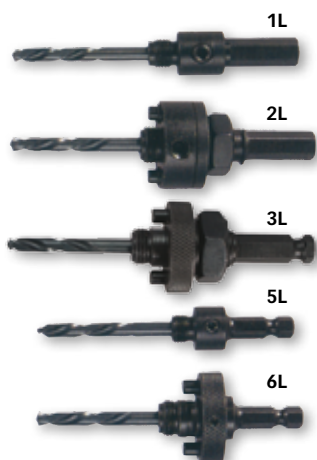

**TOEBEHOREN VOOR GATZAGEN • ACCESSOIRES POUR SCIES-TRÉPANS**

code			Ø					€	
				mm	mm				
<b>Hexagonale houders • Mandrins hexagonals</b>									
LX 1779774	1L		0885363004755	14-30	≥ 13 (HEX)	101 gr	1	1	<b>18,33</b>
LX 1779801	2L		0885363004762	32-152	≥ 13 (HEX)	217 gr	1	1	<b>30,99</b>
LX 1779802	3L		0885363004779	32-152	≥ 13 (HEX/SOLID)	225 gr	1	1	<b>30,52</b>
LX 1779804	5L		0885363004793	14-30	≥ 10 (HEX)	78 gr	1	1	<b>18,78</b>
LX 1779805	6L		0885363004809	32-152	≥ 10 (HEX)	161 gr	1	1	<b>28,55</b>



<b>"Quick-Change" houder • Mandrin "Quick-Change"</b>									
LX 1768811	2L		5706915077667	32-152	≥ 13 (HEX)	281 gr	1	1	<b>34,59</b>



<b>Verlengstukken • Rallonges</b>									
LX 30847-12			0082472308471	1L - 2L - 3L	300	395 gr	1	1	<b>20,90</b>
<b>Centreerboren • Forets de centrage</b>									
LX 1779771			0885363004663	1L - 2L - 4L	Ø 6,4 x 109	24 gr	1	1	<b>6,26</b>
LX 1779810			0885363004823	3L - 5L - 6L - 7L	Ø 6,4 x 83	20 gr	1	1	<b>5,55</b>

**PROTOOL LUBE snijvloeistof • Lubrifiant de coupe PROTOOL LUBE**

code							€
LX 68040	vrac	0082472680409	170 ml	223 gr	12	12	<b>9,94</b>



WITH **WELDTEC™**

42 mm

Bi-Metaal, precisie vertanding voor optimale resultaten in:  
aluminium - koper - ijzer - roestvrij staal - hout - zink - gipsplatenBi-métal, denture de précision pour résultat optimal dans:  
aluminium - cuivre - fer - acier inoxydable - bois - zinc - plaques de plâtre

code			Ø				€
mm							
IR 10504161			14	40 gr	1	1	12,92
IR 10504162			16	40 gr	1	1	9,94
IR 10504163			17	46 gr	1	1	9,94
IR 10504164			19	48 gr	1	1	9,94
IR 10504165			20	49 gr	1	1	9,94
IR 10504166			21	50 gr	1	1	9,94
IR 10504167			22	52 gr	1	1	9,94
IR 10504168			24	60 gr	1	1	9,94
IR 10504169			25	68 gr	1	1	10,49
IR 10504170			27	70 gr	1	1	10,49
IR 10504171			29	80 gr	1	1	10,49
IR 10504172			30	86 gr	1	1	10,49
IR 10504173			32	92 gr	1	1	10,49
IR 10504174			33	106 gr	1	1	10,49
IR 10504175			35	110 gr	1	1	10,49
IR 10504176			37	112 gr	1	1	11,34
IR 10504177			38	114 gr	1	1	11,34
IR 10504178			40	115 gr	1	1	11,34
IR 10504179			41	116 gr	1	1	11,34
IR 10504180			43	118 gr	1	1	11,34
IR 10504181			44	120 gr	1	1	14,18
IR 10504182			46	122 gr	1	1	14,83
IR 10504183			48	124 gr	1	1	14,83
IR 10504184			51	126 gr	1	1	14,83
IR 10504185			52	128 gr	1	1	17,32
IR 10504186			54	158 gr	1	1	17,32
IR 10504187			57	164 gr	1	1	17,32

code			Ø				€
mm							
IR 10504188			59	168 gr	1	1	17,32
IR 10504189			60	172 gr	1	1	17,32
IR 10504190			64	174 gr	1	1	18,72
IR 10504191			65	178 gr	1	1	18,72
IR 10504192			67	184 gr	1	1	18,72
IR 10504193			68	188 gr	1	1	18,72
IR 10504194			70	195 gr	1	1	18,72
IR 10504195			73	204 gr	1	1	18,72
IR 10504196			76	251 gr	1	1	19,40
IR 10504197			79	280 gr	1	1	19,68
IR 10504198			83	300 gr	1	1	19,68
IR 10504199			86	320 gr	1	1	19,68
IR 10504200			89	340 gr	1	1	19,68
IR 10504201			92	360 gr	1	1	23,42
IR 10504202			95	398 gr	1	1	24,93
IR 10504203			98	413 gr	1	1	26,56
IR 10504204			102	430 gr	1	1	29,48
IR 10504205			105	455 gr	1	1	30,34
IR 10504206			108	470 gr	1	1	36,83
IR 10504207			111	500 gr	1	1	44,41
IR 10504208			114	540 gr	1	1	47,83
IR 10504209			117	570 gr	1	1	49,36
IR 10504210			121	610 gr	1	1	51,50
IR 10504211			127	670 gr	1	1	58,46
IR 10504212			140	730 gr	1	1	72,36
IR 10504213			152	750 gr	1	1	87,37

## TOEBEHOREN VOOR GATZAGEN • ACCESSOIRES POUR SCIES-TRÉPANS



IR 10504534

code			Ø				€
mm							
<b>Houders - schacht 9,5 mm • Mandrins - tige 9,5 mm</b>							
IR 10504536			14 → 30	102 gr	1	1	11,63
IR 10504534			32 → 152	271 gr	1	1	19,85
<b>Houder - schacht 13 mm • Mandrin - tige 13 mm</b>							
IR 10504535			32 → 210	250 gr	1	1	21,29
<b>Centreerboor • Foret pilote</b>							
IR 10504532			Ø 6,35 x 76 mm	27 gr	5	1	4,26

Bi-Metaal gatzagensets in koffer  
Sets de scies-trépan bi-métal en coffret



























































code							€
<b>4-delig (incl. houders en centreerboren) • 4 pièces (mandrins et forets pilote incl.)</b>							
IR 10507235	koffer/coffre		Ø 22 - 35 - 65 - 67 mm	1235 gr	1	1	104,64









**Bi-Metaal, variabele vertanding voor optimale resultaten in hout en metaal**  
**Bi-métal à dents variable pour résultat optimal dans le bois et le métal**









code			Ø				€
			mm				
LA JA001400		8713974008461	14	28 gr	1	1	<b>4,56</b>
LA JA001600		8713974008478	16	31 gr	1	1	<b>4,69</b>
LA JA001700		8713974008485	17	33 gr	1	1	<b>4,92</b>
LA JA001900		8713974008492	19	35 gr	1	1	<b>5,29</b>
LA JA002000		8713974008508	20	38 gr	1	1	<b>5,36</b>
LA JA002100		8713974008515	21	43 gr	1	1	<b>5,71</b>
LA JA002200		8713974008522	22	47 gr	1	1	<b>5,97</b>
LA JA002400		8713974008539	24	55 gr	1	1	<b>6,15</b>
LA JA002500		8713974008546	25	58 gr	1	1	<b>6,28</b>
LA JA002700		8713974008553	27	67 gr	1	1	<b>7,01</b>
LA JA002900		8713974008560	29	76 gr	1	1	<b>7,34</b>
LA JA003000		8713974008577	30	79 gr	1	1	<b>7,37</b>
LA JA003200		8713974008584	32	87 gr	1	1	<b>7,61</b>
LA JA003300		8713974008591	33	82 gr	1	1	<b>7,80</b>
LA JA003500		8713974008607	35	91 gr	1	1	<b>7,98</b>
LA JA003700		8713974008614	37	75 gr	1	1	<b>8,34</b>
LA JA003800		8713974008621	38	74 gr	1	1	<b>8,66</b>
LA JA004000		8713974008638	40	82 gr	1	1	<b>9,04</b>
LA JA004100		8713974008652	41	84 gr	1	1	<b>9,16</b>
LA JA004300		8713974008669	43	92 gr	1	1	<b>9,39</b>
LA JA004400		8713974008676	44	96 gr	1	1	<b>9,54</b>
LA JA004600		8713974008683	46	106 gr	1	1	<b>10,04</b>
LA JA004800		8713974008690	48	114 gr	1	1	<b>10,40</b>
LA JA005100		8713974008706	51	127 gr	1	1	<b>10,97</b>
LA JA005200		8713974008713	52	129 gr	1	1	<b>11,20</b>
LA JA005400		8713974008720	54	138 gr	1	1	<b>11,63</b>
LA JA005700		8713974008737	57	153 gr	1	1	<b>11,99</b>
LA JA005900		8713974008751	59	164 gr	1	1	<b>12,40</b>
LA JA006000		8713974008768	60	166 gr	1	1	<b>12,89</b>
LA JA006400		8713974008775	64	183 gr	1	1	<b>13,16</b>
LA JA006500		8713974008782	65	188 gr	1	1	<b>13,38</b>
LA JA006700		8713974008799	67	198 gr	1	1	<b>14,52</b>
LA JA006800		8713974008805	68	203 gr	1	1	<b>14,82</b>
LA JA007000		8713974008812	70	213 gr	1	1	<b>15,04</b>
LA JA007300		8713974008829	73	231 gr	1	1	<b>15,80</b>
LA JA007600		8713974008836	76	264 gr	1	1	<b>16,41</b>
LA JA007900		8713974008843	79	281 gr	1	1	<b>17,05</b>
LA JA008300		8713974008850	83	305 gr	1	1	<b>17,74</b>
LA JA008600		8713974008867	86	320 gr	1	1	<b>17,93</b>
LA JA008900		8713974008874	89	340 gr	1	1	<b>19,60</b>
LA JA009200		8713974008881	92	357 gr	1	1	<b>20,10</b>
LA JA009500		8713974008898	95	388 gr	1	1	<b>20,81</b>
LA JA009800		8713974008904	98	408 gr	1	1	<b>21,33</b>
LA JA010200		8713974008911	102	439 gr	1	1	<b>21,96</b>
LA JA010500		8713974008928	105	458 gr	1	1	<b>22,79</b>
LA JA010800		8713974008935	108	479 gr	1	1	<b>23,60</b>
LA JA011100		8713974008942	111	503 gr	1	1	<b>24,42</b>
LA JA011400		8713974008959	114	554 gr	1	1	<b>25,57</b>
LA JA012100		8713974008966	121	598 gr	1	1	<b>26,74</b>
LA JA012700		8713974008973	127	644 gr	1	1	<b>28,77</b>
LA JA014000		8713974008980	140	769 gr	1	1	<b>31,49</b>
LA JA014600		8713974008997	146	812 gr	1	1	<b>33,05</b>
LA JA015200		8713974009000	152	833 gr	1	1	<b>34,25</b>

## TOEBEHOREN VOOR GATZAGEN • ACCESSOIRES POUR SCIES-TRÉPANS



code			Ø				€
			mm				
<b>Hexagonale houders • Mandrins hexagonals</b>							
LA JA105519	vrac	8713974008409	14-30	70 gr	1	1	<b>6,62</b>
LA JA105520	vrac	8713974009017	32-51	96 gr	1	1	<b>7,25</b>
<b>Snelwisselhouder Quick change • Mandrins verrouillage rapide</b>							
LA JA105545	vrac	8713974009031	32-210	218 gr	1	1	<b>9,18</b>
<b>Snelwisselhouder SDS+ • Mandrin SDS+</b>							
LA JA105580	vrac	8713974013540	32-210	228 gr	1	1	<b>11,19</b>
<b>Centreerboren • Forets pilote</b>							
LA JA108534	vrac	8713974012734	Ø 6,3 x 75	15 gr	5	1	<b>1,61</b>
LA JA108535	vrac	8713974012741	Ø 6,3 x 104	21 gr	5	1	<b>1,61</b>
<b>Verlengstuk • Rallonge</b>							
LA JA105500	vrac	8713974002490	300	300 gr	1	1	<b>6,73</b>
<b>Verloopnippel • Bague entretoise</b>							
LA JA105511	vrac	8713974002995	-	16 gr	1	1	<b>2,91</b>

**Bi-Metaal gatzagensets in kunststof koffer**  
**Sets de scies-trépan bi-métal en coffret plastique**

code							€
LA JA109592	koffer/coffre	8713974016282	loodgieter / plombier	1074 gr	1	1	<b>70,92</b>
LA JA109593	koffer/coffre	8713974016299	elektricien / électricien	1187 gr	1	1	<b>76,38</b>
LA JA109596	koffer/coffre	8713974016305	installateur	1375 gr	1	1	<b>98,21</b>
LA JA109598	koffer/coffre	8713974016275	combi	1766 gr	1	1	<b>113,96</b>

Samenstelling Composition	LA 9592 9-delig/pcs	LA 9593 9-delig/pcs	LA 9596 13-delig/pcs	LA 9598 14-delig/pcs
Ø 19	•		•	•
Ø 20				
Ø 22	•	•	•	•
Ø 25				•
Ø 29	•	•	•	•
Ø 32				•
Ø 35		•	•	•
Ø 38	•	•	•	•
Ø 44	•	•	•	•
Ø 51		•	•	•
Ø 57	•		•	•
Ø 64		•	•	•
Ø 68				
Ø 76				•
Ø 83				
Houders Mandrins	1 x Ø14→30mm 1 x Ø32→210mm	1 x Ø14→30mm 1 x Ø32→210mm	1 x Ø14→30mm 1 x Ø32→210mm	1 x Ø14→30mm 1 x Ø32→210mm
Centreerboren Forets pilote			•	
Verloopnippel Bague entretoise	•	•	•	•



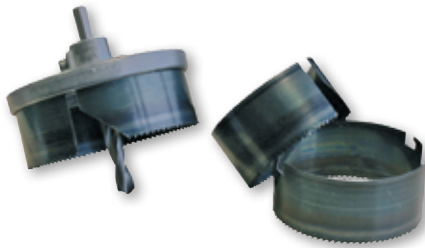

### Gatzaag met 3 afneembare bladen Scies-tréfans avec 3 lames amovibles

code							€
			mm				
CP 389001		4022307121277	60 - 67 - 74	276 gr	1	1	<b>20,98</b>
CP 389002		4022307121284	72 - 80 - 95	415 gr	1	1	<b>30,77</b>

Speciaal voor hout • Spécial pour le bois

### Hardmetalen gatborenssets Sets scies-tréfans au carbure de tungstène

**NEW**

code			Ø				€
			mm				
<b>6-delige set • Set de 6 pièces</b>							
SO 300640		5420000042391	33 - 53 - 67 - 73 ring / support 83 mm centreerboor / foret pilote	734 gr	24	1	<b>21,20</b>
<b>9-delige kunststofkoffer set • Coffret en plastique de 9 pièces</b>							
SO 301745	koffer/coffre	5420000042407	33 - 43 - 53 - 67 - 73 - 83 ring / support 83 mm centreerboor / foret pilote + tegelvijl / lime	1846 gr	10	1	<b>42,30</b>



SO 300200



**NEW**

### TOEBEHOREN • ACCESSOIRES

code							€
			mm				
<b>Opmatering ALU • Support ALU</b>							
SO 300200		5420000042384	33 - 43 - 53 - 67 - 73 - 83	132 gr	1	1	<b>4,96</b>
<b>Centreerboor hardmetaal • Foret pilote en carbure de tungstène</b>							
SO 300100		5420000042377	-	79 gr	1	1	<b>3,90</b>



SO 300100





## Handzaag machines 220V • Machine à main 220V



'Alternate Top Bevel'-veranding (ATB) voor het dwars zagen en schulpen van alle houtsoorten. Hardmetalen carbidepunten van industriële kwaliteit blijven langer scherp

Technologie ATB (denture biseau alterné) pour couper parfaitement tous les bois  
Dents en carbure de tungstène de qualité industrielle plus résistantes et réaffûtâbles

Volledig geharde plaat - Roestbestendige coating voor langdurige prestaties

Corps trempé - Revêtement résistant à la corrosion pour une performance de qualité plus durable

Expansiesleuven voeren hitte af en voorkomen kromtrekken  
Rainures de dilatation thermique pour éviter le gauchissement

## Cirkelzaagbladen - OPP • Lames de scies circulaires - OPP

code												€
			mm	mm	mm	#	mm					
IR 1897090		5706918970903	150	20	16	30	2,5	272 gr	1	1		<b>28,33</b>
IR 1897191		5706918971917	160	20	16	18	2,5	277 gr	1	1		<b>24,46</b>
IR 1907698		5706919076987	160	30	16 - 20	24	2,5	319 gr	1	1		<b>27,65</b>
IR 1897192		5706918971924	160	20	16	30	2,5	277 gr	1	1		<b>28,72</b>
IR 1897193		5706918971931	165	30	16 - 20	18	2,5	291 gr	1	1		<b>26,01</b>
IR 1897194		5706918971948	165	30	16 - 20	30	2,5	291 gr	1	1		<b>32,67</b>
IR 1897199		5706918971993	190	30	16 - 20	24	2,5	291 gr	1	1		<b>29,71</b>
IR 1897200		5706918972006	190	30	16 - 20	40	2,5	366 gr	1	1		<b>44,40</b>
IR 1897203		5706918972037	210	30	16 - 20	20	2,5	420 gr	1	1		<b>31,37</b>
IR 1897204		5706918972044	210	30	16 - 20	40	2,5	454 gr	1	1		<b>47,84</b>
IR 1897206		5706918972068	230	30	16 - 20	40	2,8	638 gr	1	1		<b>55,99</b>
IR 1897207		5706918972075	235	30	16 - 20	20	2,8	600 gr	1	1		<b>40,68</b>
IR 1897208		5706918972082	235	30	16 - 20	40	2,8	622 gr	1	1		<b>56,59</b>

## Vaste machines • Machines stationnaires



## Cirkelzaagbladen - OPP • Lames de scies circulaires - OPP

code												€
			mm	mm	mm	#	mm					
IR 1907700		5706919077007	250	30	16 - 20 - 25	60	3	901 gr	1	1		<b>79,06</b>
IR 1897212		5706918972129	300	30	-	48	3,2	1300 gr	1	1		<b>84,78</b>
IR 1897213		5706918972136	300	30	-	60	3,2	1300 gr	1	1		<b>94,79</b>
IR 1897214		5706918972143	315	30	-	40	3,2	1415 gr	1	1		<b>81,19</b>
IR 1897215		5706918972150	350	30	-	40	3,5	1972 gr	1	1		<b>108,02</b>
IR 1897347		5706918973478	400	30	-	40	3,8	2814 gr	1	1		<b>114,66</b>
IR 1897348		5706918973485	400	30	-	60	3,8	2814 gr	1	1		<b>124,47</b>

**Handzaag machines 220V • Machine à main 220V**



Gelaste carbidetanden  
30 % sterkere hechting van de tanden voor een dubbele langere levensduur  
Dents soudées au carbure  
Soudure 30 % plus solide pour une durée de vie 2 x plus longue

70 % harder dan standaardcarbide voor een grotere scherpte en een hogere zaagkwaliteit  
70 % plus robuste que le carbure standard pour un tranchant plus acéré et une qualité supérieure

Volledig geharde plaat - Roestbestendige coating voor langdurige prestaties  
Corps trempé - Revêtement résistant à la corrosion pour une performance de qualité plus durable

Innovatieve ventilatiegaten voor afvoer van hitte  
Rainures de dilatation thermiques innovantes

Vertanding ANTI KICK-BACK  
Denture ANTI KICK-BACK

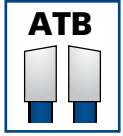

**Cirkelzaagbladen - MPP • Lames de scies circulaires - MPP**

code											€
			mm	mm	mm	#	mm				
IR 1897362		5706918973621	160	20	16	24	2,4	292 gr	1	1	<b>35,94</b>
IR 1897363		5706918973638	160	20	16	40	2,4	292 gr	1	1	<b>36,85</b>
IR 1897365		5706918973652	165	30	20	24	2,4	306 gr	1	1	<b>31,21</b>
IR 1897366		5706918973669	165	30	20	40	2,4	306 gr	1	1	<b>37,58</b>
IR 1897382		5706918973829	190	30	20	18	2,4	387 gr	1	1	<b>34,60</b>
IR 1897383		5706918973836	190	30	20	24	2,4	387 gr	1	1	<b>36,34</b>
IR 1897384		5706918973843	190	30	20	40	2,4	387 gr	1	1	<b>57,67</b>
IR 1897385		5706918973850	210	30	20	24	2,4	479 gr	1	1	<b>39,54</b>
IR 1897386		5706918973867	210	30	20	40	2,4	479 gr	1	1	<b>62,14</b>
IR 1897387		5706918973874	235	30	20	20	2,4	600 gr	1	1	<b>47,49</b>
IR 1897388		5706918973881	235	30	20	40	2,4	600 gr	1	1	<b>73,55</b>
IR 1897389		5706918973898	235	30	20	60	2,4	600 gr	1	1	<b>62,80</b>

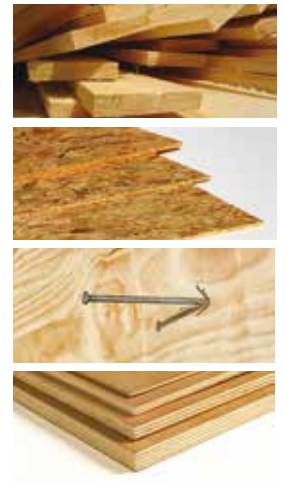

**Vaste machines • Machines stationnaires**

'Alternate Top Bevel'-vertanding (ATB) voor het dwars zagen en schulpen van alle houtsoorten  
Technologie ATB (denture biseau alterné) pour couper parfaitement tous les bois

Volledig geharde plaat - Roestbestendige coating voor langdurige prestaties  
Corps trempé - Revêtement résistant à la corrosion pour une performance de qualité plus durable

Hardmetalen wolframcarbidepunten van industriële kwaliteit blijven langer scherp en kunnen tot 3 keer worden geslepen  
Dents en carbure de tungstène de qualité industrielle plus résistantes et jusqu'à 3 fois réaffûtâbles

Expansiesleuven voeren hitte af en voorkomen kromtrekken  
Rainures de dilatation thermique pour éviter le gauchissement

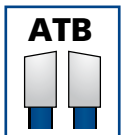

**Cirkelzaagbladen - MPP • Lames de scies circulaires - MPP**

code											€
			mm	mm	mm	#	mm				
IR 1897431		5706918974314	260	30	-	48	2,8	905 gr	1	1	<b>56,99</b>
IR 1897432		5706918974321	260	30	-	60	2,8	905 gr	1	1	<b>63,86</b>
IR 1897433		5706918974338	260	30	-	80	2,8	905 gr	1	1	<b>85,89</b>
IR 1897434		5706918974345	305	30	-	48	3,2	1337 gr	1	1	<b>62,10</b>
IR 1897435		5706918974352	305	30	-	60	3,2	1337 gr	1	1	<b>71,45</b>

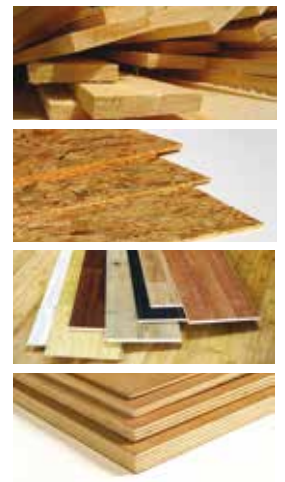



#### Vaste machines • Machines stationnaires

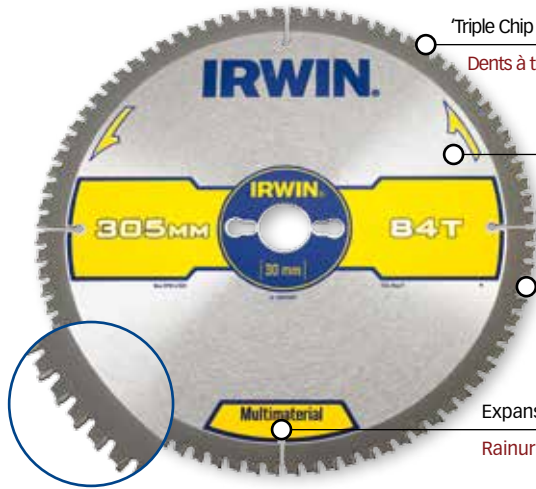

'Triple Chip Ground'-veranding (TCG) voor een uitstekende afwerking van de snede

Dents à triple biseau pour une finition parfaite de la coupe

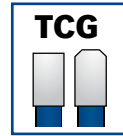

Volledig geharde plaat - Roestbestendige coating voor langdurige prestaties

Corps trempé - Revêtement résistant à la corrosion pour une performance de qualité plus durable

Hardmetalen wolframcarbidepunten van industriële kwaliteit blijven langer scherp en kunnen tot 3 keer worden geslepen

Dents en carbure de tungstène de qualité industrielle plus résistantes et jusqu'à 3 fois réaffûtables

Expansiesleuven voeren hitte af en voorkomen kromtrekken

Rainures de dilatation thermique pour éviter le gauchissement

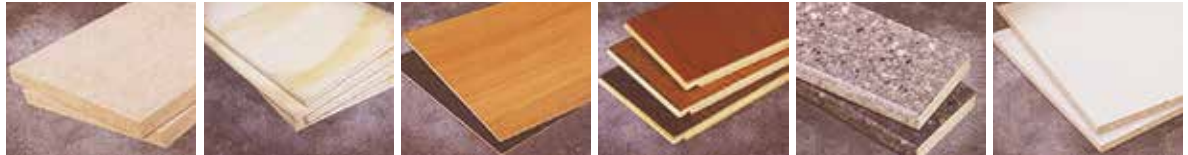

#### Cirkelzaagbladen - MULTI • Lames de scies circulaires - MULTI

code												€
			mm	mm	mm	#	mm					
● IR 1897437		5706918974376	160	20	16	48	2,4	280 gr	1	1		<b>43,61</b>
IR 1897439		5706918974390	184	30	16 - 20	48	2,4	347 gr	1	1		<b>56,47</b>
IR 1897444		5706918974444	254	30	-	84	2,6	870 gr	1	1		<b>85,54</b>
IR 1897447		5706918974475	305	30	-	84	2,6	1232 gr	1	1		<b>113,17</b>

